

FPM-215W

15.6" FHD Industrial Monitor with P-CAP Touch Control, Direct HDMI Port



Features

- 15.6" FHD TFT LED LCD with true-flat touchscreen
- 16:9 wide screen aspect ratio, increases viewing area by 40%
- Supports 10-point multi-touch control via USB interface in Windows 7/8/10 OS
- Slim design enables easy installation
- Supports various mount options: panel, desktop, and VESA arm
- Touchscreen with reliable glass surface and P-CAP touch control
- Robust system with Die-casting aluminum chassis and IP66-rated aluminum alloy front bezel
- Lockable I/O connectors

Introduction

In IIoT and Industry 4.0, more and more customers need data to be visualized to help process management and decision making. The FPM-215W is an industrial-grade, widescreen monitor with sleek, simple lines and a true-flat touchscreen. Equipped with P-CAP 10-point multi-touch control and an IP66-rated front bezel, FPM-215W is designed for intuitive operation in industrial environments such as smart factory and machine automation display applications.

Specifications

General

- **Certification** BSMI, CCC, CE, FCC Class A, UL, CB
- **Dimensions (W x H x D)** 419.7 x 269 x 56.2 mm (16.52" x 10.59" x 2.21")
- **Enclosure** Front panel: Die-casting aluminium, Rear cover: Die-casting aluminium
- **Mounting** Panel, VESA arm
- **Power Input** External 60 W power adapter, with AC 100 V ~ 240 V input and DC +12 V @ 5 A output (included)
- **Video Port** HDMI
- **Weight (Net)** 4kg (8.82 lb)

LCD Display

- **Display Type** FHD TFT LED LCD
- **Display Size** 15.6"
- **Max. Resolution** 1920 x 1080
- **Max. Color** 16.7M
- **Viewing Angle (H/V)°** 89/89
- **Luminance (cd/m²)** 350
- **Backlight Life (hrs)** 50,000
- **Contrast Ratio** 1000:1

Touchscreen

- **Type** Projected capacitive touch
- **Interface** USB
- **OS Support** Windows® 7, 8, 10, 11, XPe, CE and Linux
- **Hardness** 7H
- **Multi Touch** 10 points, USB interface in Win 7/8/10, Linux

Environment

- **Operation Temperature** 0 ~ 50°C (32 ~ 122°F)
- **Storage Temperature** -20 ~ 60°C (-4 ~ 140°F)
- **Humidity (Storage)** 10 ~ 95% non-condensing
- **Waterproof** Front Panel IP66 Compliant
- **Vibration** 5 ~ 500 Hz, 1 Grms (Operating, Random)

Ordering Information

- **FPM-215W-P4BE** 15.6" FHD Ind. Monitor, w/ PCAP touch (Adapter included)

Optional Accessories

- **FPM-1000T-SMKE** Desktop Mounting kit for FPM series
- **1702002605** Power Cable EU Plug 1.8 M
- **1702031801** Power Cable UK Plug 1.8 M
- **1700000596** Power Cable China/Australia Plug 1.8 M
- **1702002600** Power Cable US Plug 1.8 M
- **FPM-200W-ADKE** Adapter bracket for FPM-200W

Dimensions

Unit: mm

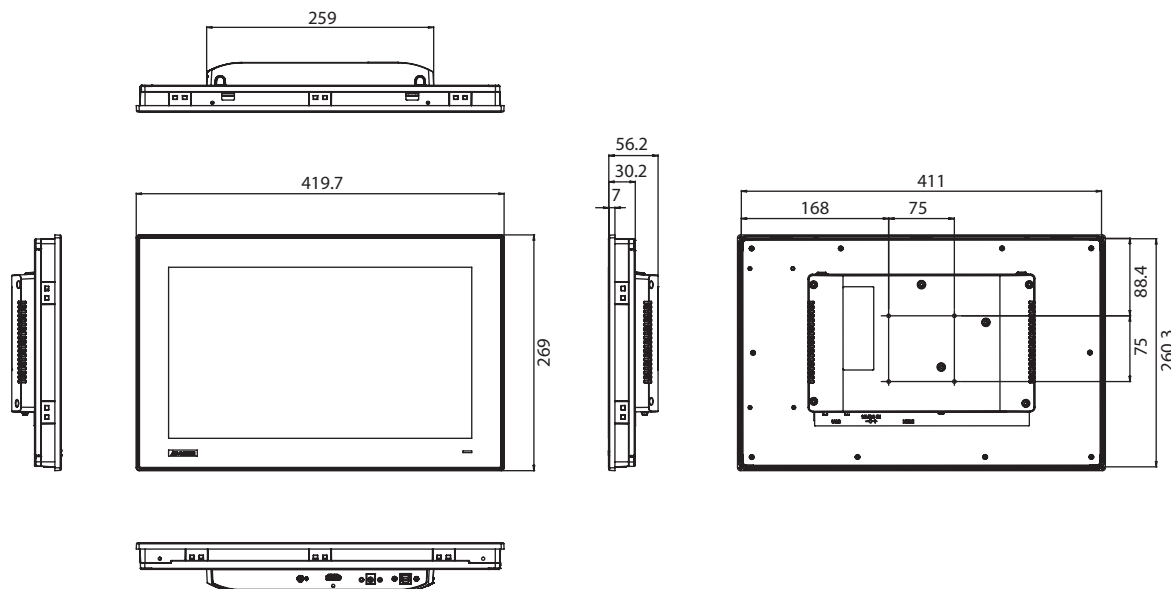

Cut-out Dimensions: 412.40 x 261.70 mm (16.24 x 10.30 in)

Front View



Rear View

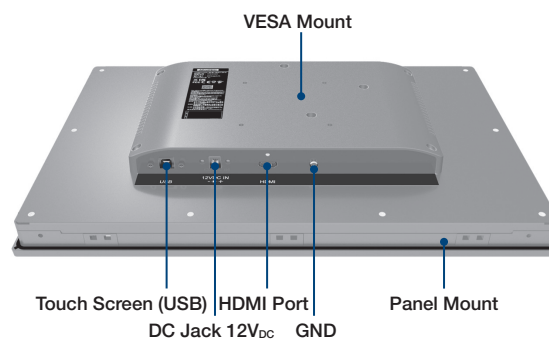

Packing list

Item	Part No.	Description	Qty
Adapter	96PSA-A60W12V1-4	ADP A/D 100-240V 60W 12V C14 DC PLUG 180°	1
USB touch Cable	1700017851-01	M Cable USB-A 4P(M)/USB-B 4P(M) 169CM (BK)	1
HDMI Cable	1700026930-01	M CABLE HDMI 19P(M)/HDMI 19P(M) 2M PCM-2901	1
Clamper	1960064704T000	Clamper for PPC-3120	10
Clamper screw	1930005598	Screw SP/S M6*21L D=9 H=2+ ST BZn	10
Cable lock for adapter	1960098895N001	Plug bracket(UNO silver) for FPM-200 series	1
Cable lock for adapter	1930001074	Screw M3x5L R/S D=5.5 H=2 (2+) ST Ni NK	2
Cable lock for HDMI	1990022422S000	Fixed rail 71.3Lx6.2W mm YJC-64C for UBC-DS31	1
Cable lock for HDMI	1990022423S000	Fixed ring DIA:7.5-8.5 FWM-8K for UBC-DS31	1